

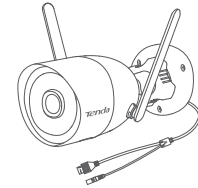

Quick Installation Guide

Outdoor Wi-Fi Camera
CT6

Package contents



Camera x 1



Power adapter x 1

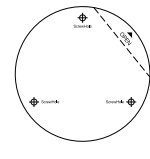

Installation template x 1

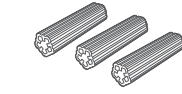

Anchor x 3
(Height: 6.6 mm, Inner diameter: 2.4 mm,
Length: 26.4 mm)

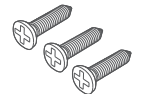

Screw x 3
(BA3 x 25 mm, Head diameter: 6.0 mm)

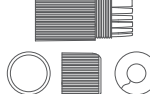

Waterproof kit x 1

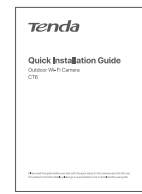

Quick installation guide x 1

Please read this guide before you start with the quick setup for this camera upon the first use.
For product or function details, please go to www.tendacn.com to download the user guide.

Appearance

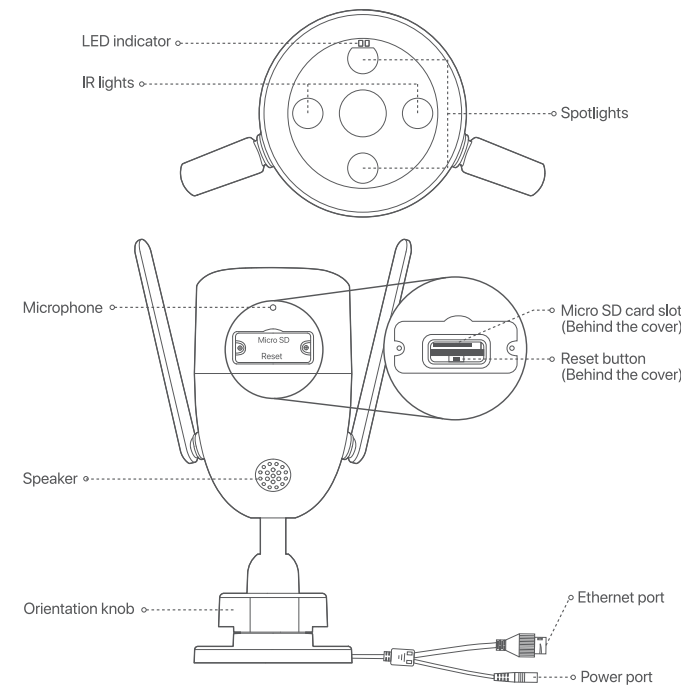

LED indicator	Solid red: Initializing and starting. Blinking red slowly: Disconnected from a 2.4 GHz Wi-Fi network. Blinking red quickly: Connecting to a 2.4 GHz Wi-Fi network. Solid blue: Connected to a 2.4 GHz Wi-Fi network. Blinking blue slowly: Upgrading. Blinking blue quickly: Waiting to connect to a 2.4 GHz Wi-Fi network.
Ethernet port	10/100Mbps auto-negotiation Ethernet port, used for connecting the router, switch and so on.
Reset button	Hold down the Reset button for about 5 seconds and release it when the LED indicator blinks blue quickly or hear a prompt tone. The camera is reset successfully.
Orientation knob	Adjust the monitoring angle for the best view via your camera.

Add the camera to TDSEE App

Tips
Before adding your camera, please ensure that the router is connected to the internet successfully and the filter function is disabled.

1. Download the **TDSEE** App onto your mobile device by searching for **TDSEE** in the **Google Play** or **App Store** or by scanning the QR code.



Or



QR code

2. Power on the camera.

The LED indicator lights solid red after the camera is powered on. When the LED indicator blinks blue quickly, the camera is waiting to connect to a 2.4 GHz Wi-Fi network.

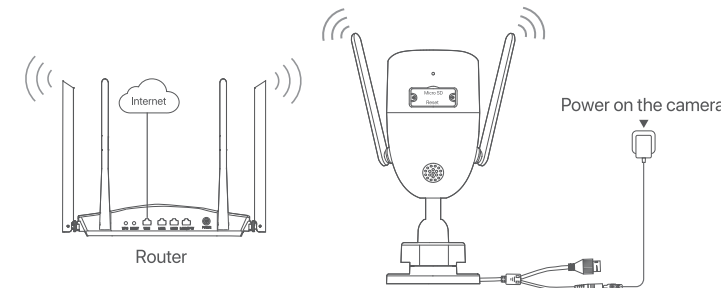

3. Run the **TDSEE** App and follow the instructions to complete user registration. Enter the **Home** page, then tap **Add a device** or the upper right corner of the home page.

4. Scan the QR code on the body of the camera, and follow the instructions in the App.

Install the device

Install the camera

The camera supports ceiling and wall installation.

Tips
(1) Please make sure the ceiling is strong enough to withstand three times the weight of the camera.
(2) You may need a hammer drill, a drill bit, rubber hammer, a screwdriver, and a ladder for the installation.

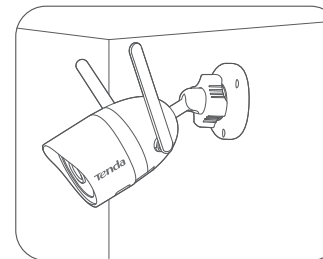
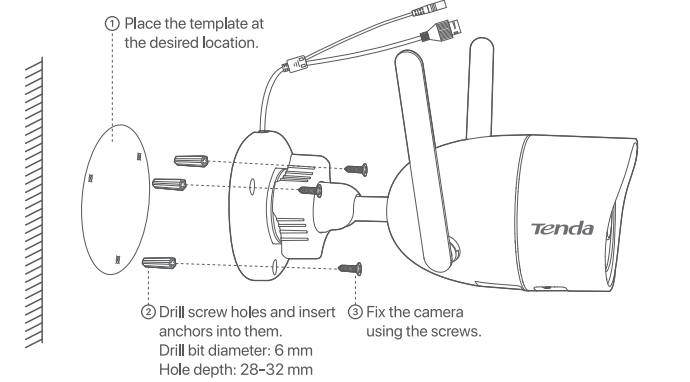

Wall installation

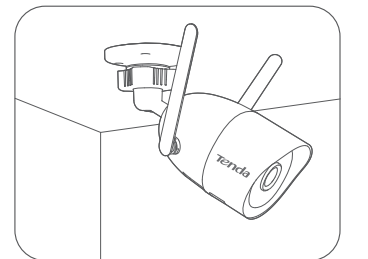

Ceiling installation

Adjust the monitoring angle

Loosen the orientation knob, adjust the orientation of the camera as required, then tighten the knob.

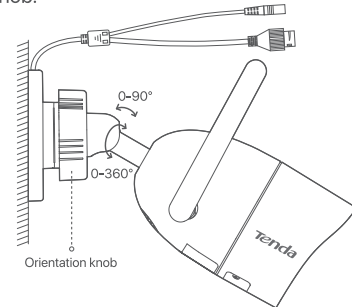

Install waterproof kit

Install the waterproof kit for the Ethernet port if the camera is installed outdoors.

Tips
The included waterproof kit is not suitable for the Ethernet cable with protection cover on the crystal head. See the example on the right.



When the Ethernet port of the camera is connected to an Ethernet cable, the waterproof installation steps are as follows. If not, you are also recommended to install the kit and wrap the end with waterproof tape.

- Put the O-ring on the Ethernet port of the camera.
- Pass the Ethernet cable through the fix nut, the waterproof ring and the waterproof jacket in proper order. Then connect it to the Ethernet port of the camera.
- Rotate to fix the waterproof jacket to the Ethernet port of the camera, insert the waterproof ring into the waterproof jacket and fasten the fix nut.

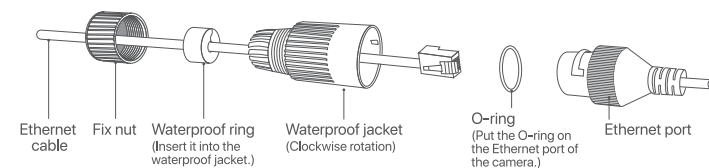

FAQ

Q1. What should I do if I failed to add the camera?

A1. Try the following solutions:

- Ensure that the router is connected to the internet successfully.
- The camera only supports 2.4 GHz Wi-Fi network. When adding the camera, you need to connect the smartphone to a 2.4 GHz Wi-Fi network.
- Do not hide the Wi-Fi network of the router when adding the camera (After adding the camera successfully, you can hide the Wi-Fi network).
- Confirm whether the LED indicator of the camera blinks blue quickly. If not, please reset the camera and configure it again.

Reset method: Hold down the **Reset** button for about 5 seconds and release it when the LED indicator blinks blue quickly or you hear a prompt tone. The camera is reset successfully.

Q2. What should I do when the video preview is not smooth?

A2. Try the following solutions:

- Check if the internet connection of the router is smooth.
- Place the router closer to the camera and adjust the antenna angle of the camera.
- When previewing the video with cellular mobile data, make sure that the internet connection of the smartphone is smooth.
- Auto**, **Fluent**, and **HD** are supported for video preview. You can switch the video clarity according to the internet status.

Q3. How to store the video?

A3. Try the following methods:

Method 1: Install the Micro SD card to the camera. The Micro SD card supports **Alarm Recording** and **All Day Recording**. By default, the recording mode is **Alarm Recording**, you can modify the recording mode according to the actual conditions.

Method: Run the **TDSEE** App, choose the camera on the **Home** page, then tap **Settings** (⚙️ in the upper right corner) → **SD Card Recording Settings**, and choose the corresponding mode.

Method 2: Subscribe the Cloud Storage Service on **TDSEE** App.

Method: Run the **TDSEE** App, choose the camera on the **Home** page, then tap **Cloud** in the lower left corner. You can enjoy free cloud storage service (7-days continuous detection recording) for 3 months upon the first activation.

Q4. How to get full-color monitoring video via the camera no matter in the daytime or at night?

A4. Set **Night Vision Mode** of the camera to **Full-color Mode**.

Method: Run the **TDSEE** App, choose the camera on the **Home** page, then tap **Settings** (⚙️ in the upper right corner) → **Night Vision Mode**, and choose **Full-color Mode**.

CE

CE Mark Warning

This is a Class A product. In a domestic environment, this product may cause radio interference, in which case the user may be required to take adequate measures. This equipment should be installed and operated with minimum distance 20cm between the device and your body.

The mains plug is used as disconnect device, the disconnect device shall remain readily operable.

NOTE: (1) The manufacturer is not responsible for any radio or TV interference caused by unauthorized modifications to this equipment. (2) To avoid unnecessary radiation interference, it is recommended to use a shielded RJ45 cable.

Declaration of Conformity

Hereby, SHENZHEN TENDA TECHNOLOGY CO., LTD. declares that the radio equipment type CT6 is in compliance with Directive 2014/53/EU.

The full text of the EU declaration of conformity is available at the following internet address: <http://www.tendacn.com/en/service/download-cata-101.html>

Operating Frequency:

2.4 GHz: EU/2412-2472MHz (CH1-CH13)

EIRP Power (Max.):

2.4 GHz: 17.5dBm

Software Version: V1.0.X

Caution:

Adapter Model: BN073-A12012E, BN073-A12012B

Manufacture: SHENZHEN TENDA TECHNOLOGY CO., LTD.

Input: 100-240V AC, 50/60Hz 0.4A

Output: 12V DC, 1A

⚡: DC Voltage

FCC

FCC Statement

This equipment has been tested and found to comply with the limits for a Class A digital device, pursuant to Part 15 of the FCC Rules. These limits are designed to provide reasonable protection against harmful interference when the equipment is operated in a commercial environment. This equipment generates, uses, and can radiate radio frequency energy and, if not installed and used in accordance with the instruction manual, may cause harmful interference to radio communications. Operation of this equipment in a residential area is likely to cause harmful interference in which case the user will be required to correct the interference at his own expense.

Operation is subject to the following two conditions: (1) this device may not cause harmful interference, and (2) this device must accept any interference received, including interference that may cause undesired operation.

Radiation Exposure Statement

This device complies with FCC radiation exposure limits set forth for an uncontrolled environment and it also complies with Part 15 of the FCC RF Rules.

This equipment should be installed and operated with minimum distance 20cm between the device and your body.

Caution!

Any changes or modifications not expressly approved by the party responsible for compliance could void the user's authority to operate the equipment.

This transmitter must not be co-located or operating in conjunction with any other antenna or transmitter.

Operating frequency: 2412-2462MHz

NOTE: (1) The manufacturer is not responsible for any radio or TV interference caused by unauthorized modifications to this equipment. (2) To avoid unnecessary radiation interference, it is recommended to use a shielded RJ45 cable.



RECYCLING

This product bears the selective sorting symbol for Waste electrical and electronic equipment (WEEE).

This means that this product must be handled pursuant to European directive 2012/19/EU in order to be recycled or dismantled to minimize its impact on the environment.

User has the choice to give his product to a competent recycling organization or to the retailer when he buys new electrical or electronic equipment.

Operating Temperature: -30°C - 60°C

Operating Humidity: (10% - 95%) RH, non-condensing



Technical Support

Shenzhen Tenda Technology Co., Ltd.

6-8 Floor, Tower E3, NO.1001, Zhongshanyuan Road, Nanshan District, Shenzhen, China. 518052

USA hotline: 1-800-570-5892

Toll Free: 7 x 24 hours

Canada hotline: 1-888-998-8966

Toll Free: Mon - Fri 9 am - 6 pm PST

Hong Kong hotline: 00852-81931998

Global hotline: +86 755-2765 7180 (China Time Zone)

Website: www.tendacn.com

E-mail: support@tenda.com.cn

Copyright

© 2021 Shenzhen Tenda Technology Co., Ltd. All rights reserved.

Tenda is a registered trademark legally held by Shenzhen Tenda Technology Co., Ltd. Other brand and product names mentioned herein are trademarks or registered trademarks of their respective holders.

Specifications are subject to change without notice.